

ISC6X3X3C

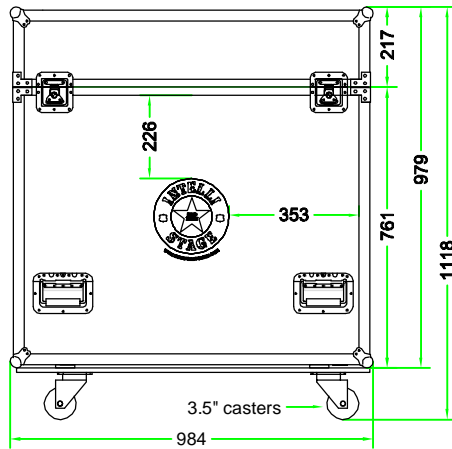

FRONT VIEW  
BACK VIEW

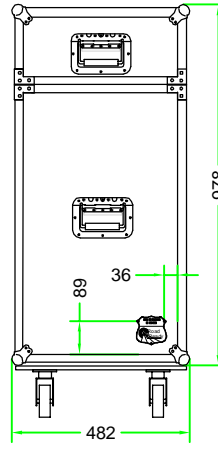

LEFT VIEW  
RIGHT VIEW

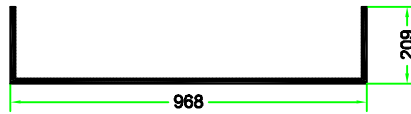

D-D VIEW

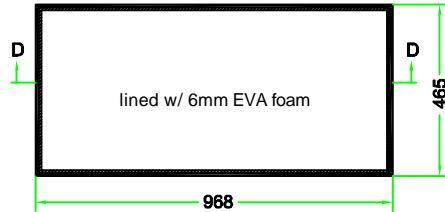

TOP VIEW OF COVER

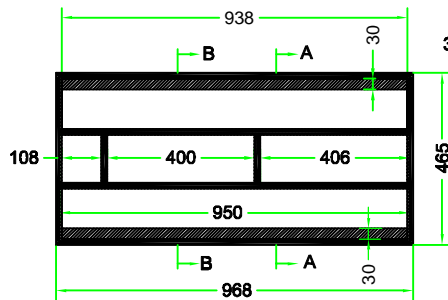

TOP VIEW OF BASE

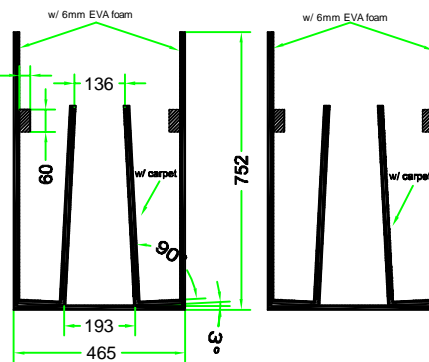

A-A VIEW

B-B VIEW

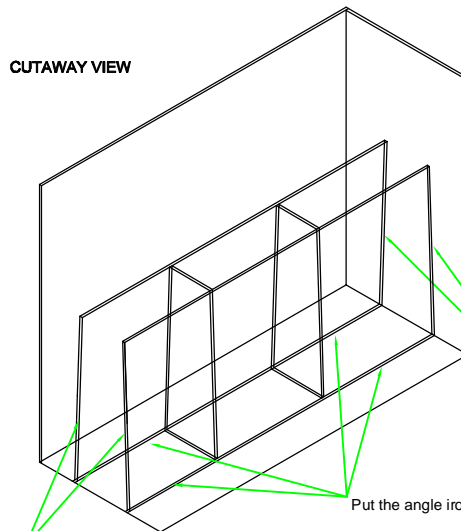

Put the angle iron to reinforce on both sides

Put the angle iron to reinforce on both sides

Put the brace reinforce on both sides