

Directions for mounting AIS/AISE, STAIR1/STAIRE1 and Handrails to IntelliStage Platform

1. Start assembly by the removing the 2 platform to platform connectors from the side of the stage where you will be attaching the stairs and replace them with the 2 assembly inserts. **Figure A**

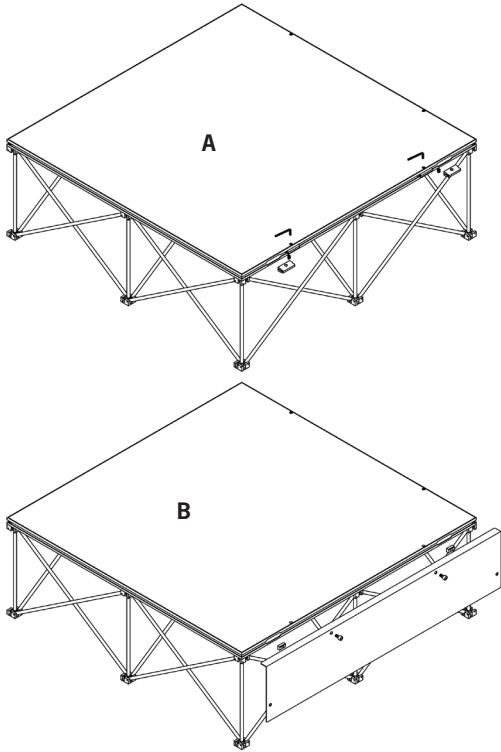

2. Attach the connecting panel to the assembly inserts on the side of the stage platform with provided screws and hex key. **Figure B and C**

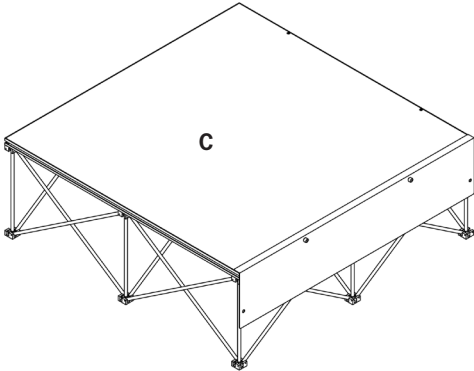

3. Attach the stairs to the connecting panel with the provided screws and hex key. **Figure D and E**

